



QUAD PORTS 10/100 BASE INTEGRATED MAGNETICS RJ45 CONNECTOR

P/N: J4A101ZCB

Feature

- Single port Tab-UP with internal magnetics for 10/100 Base-TX.
- Suitable for CAT 5 & 6 Fast Ethernet cable or better UTP.
- Internal magnetics are 100% electrically tested for HI-POT & functionality.
- 350 μ H minimum OCL with 8mA bias current.
- Meets or exceeds IEEE 802.3b standard for 10/100Base-T.
- High performance for maximum EMI suppression.
- RoHS compliant.

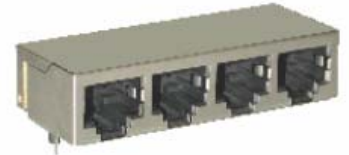

Electrical Specifications @ 25°C							
Part Number	Turns Ratio ($\pm 5\%$)		OCL(μ H Min) @ 100 KHz/0.1V with 8mA DC Bias	C_{ww} (pF Max)	L_L (μ H Max)	Insertion Loss (dB Max) @ 100KHz-100MHz	Hi-pot (Vrms) For Leakage 0.5mA/2sec
	TX	RX					
J4A101ZCB	1CT:1CT	1CT:1CT	350	28	0.4	-1.1	1500

Continue									
Part Number	Return Loss (dB Min)			Cross talk (dB Min)			Common Mode Rejection (dB Min)TX/RX		
	30MHz	60MHz	80MHz	30MHz	60MHz	100MHz	30MHz	50MHz	100MHz
J4A101ZCB	-16	-12	-10	-40	-35	-33	-30	-25	-20

RJ45 Durability Testing Rating & Material Specification				
Part Number	Durability	Mating Force	Shield	
			Material	Finish
J4A101ZCB	750 Insertions	5 lbs./2.268 kgs.	Brass	10-20m inches Nickel over 10-20m inches Brass

RJ45 Material Specification				
Part Number	Contact		Housing	
	Material	Plating Area	Material	Specification
J4A101ZCB	Phosphor Brass	10-20m inches Nickel over selective gold plating 6 μ inches	Thermoplastic	UL 94 V-0

* Operating temperature range: 0°C to +70°C. Storage temperature range: -25°C to +125°C.

Tel:+86-20-81628973	Fax:+86-20-81628967
E-mail:sales@ceetus.com.cn	Website:www.ceetus.com.cn



QUAD PORTS 10/100 BASE INTEGRATED MAGNETICS RJ45 CONNECTOR

P/N: J4A101ZCB

Schematic

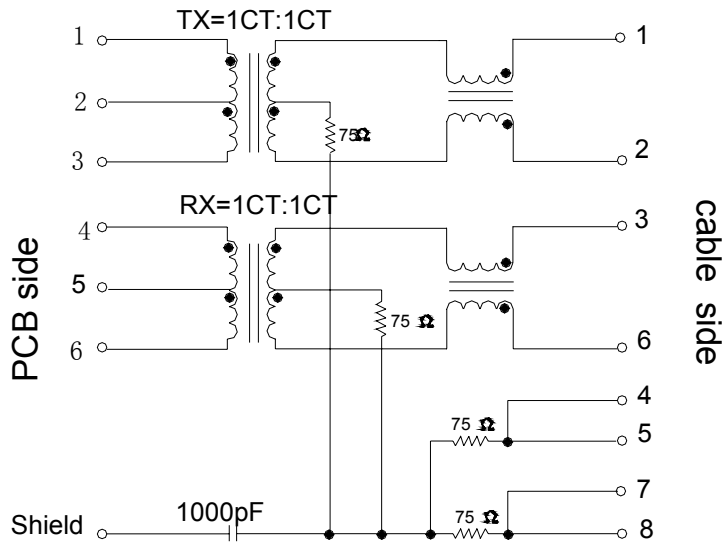

Mechanical

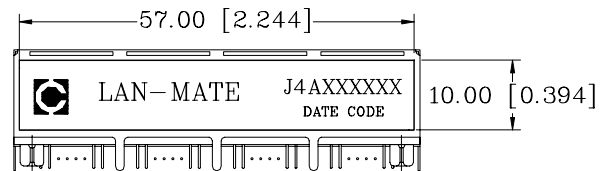
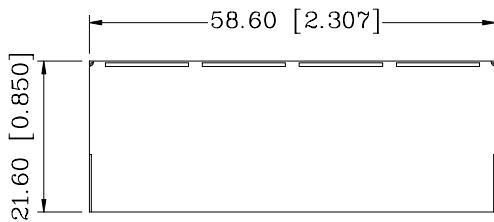

Label Drawing

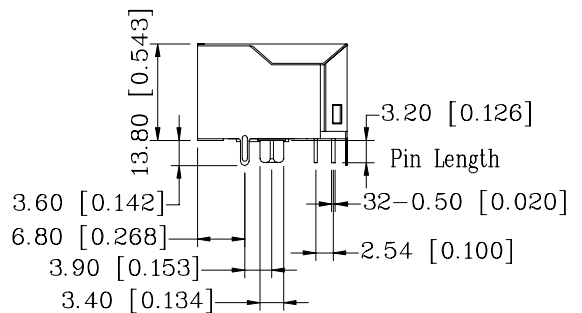
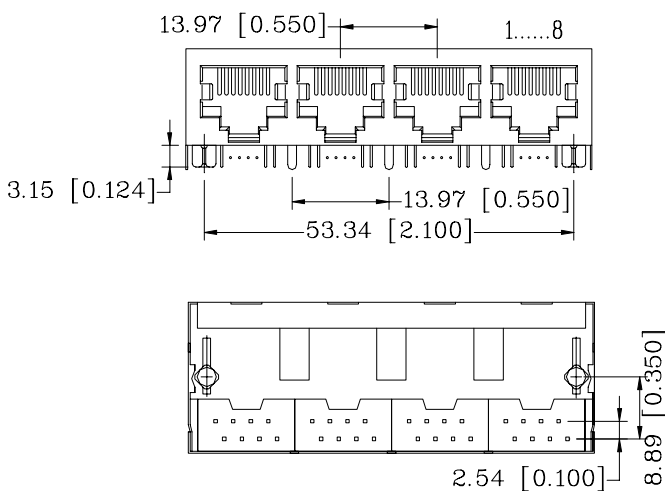

Tolerance: ± 0.25 (0.010) unless specified otherwise.

Tel:+86-20-81628973	Fax:+86-20-81628967
E-mail:sales@ceetus.com.cn	Website:www.ceetus.com.cn



QUAD PORTS 10/100 BASE INTEGRATED MAGNETICS RJ45 CONNECTOR

P/N: J4A101ZCB

PCB Layout Mounting Hole (Top View)

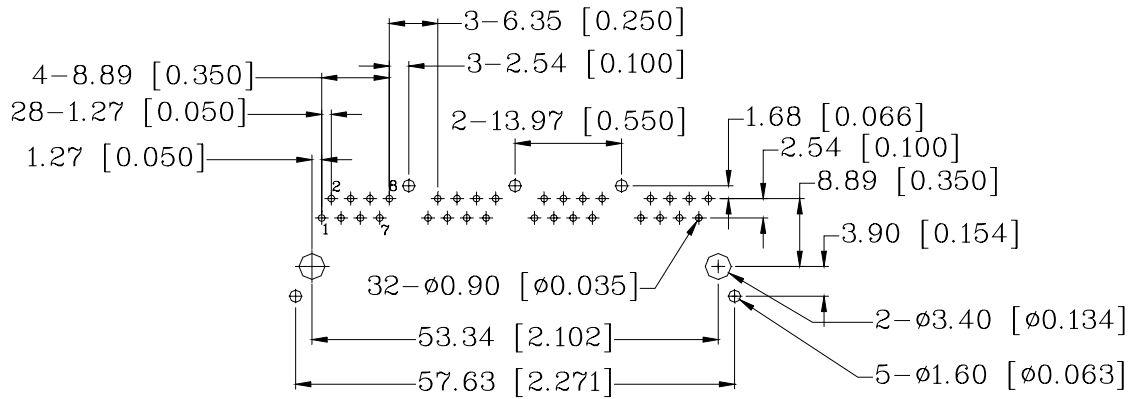

NOTE:

Datasheet Change History:

V0	2007/Mar.	Datasheet Set Up

Tel:+86-20-81628973	Fax:+86-20-81628967
E-mail:sales@ceetus.com.cn	Website:www.ceetus.com.cn